

# 使用说明书

**User Guide**

**工业包缝机**

**Industrial sewing machine**

**感谢您购买本公司的产品。**

**为了您的使用安全，请您在使用之前一定仔细阅读本使用说明书。**

**Thank you for purchasing our products.**

**For your use safety, please must read the instruction manual before use.**

# 全自动一体式电控操作手册（Qs/Ss）



## 安全事项:

- 使用本产品前，请先阅读本《操作手册》及所搭配的缝制机械说明书。
- 必须由接受过专业培训的人员来安装调试或操作。
- 本产品仅适用于指定范围的缝制机械，请勿移做他用。
- 请尽量远离高频高辐射设备，以免干扰本控制器误动作。
- 对控制箱进行安装维护时，请先关闭电源并拔掉插头。
- 请确保用电及设备可靠接地，以防止干扰和漏电事故。
- 所有维修用零件须由本公司提供或认可，方可使用。
- 在进行控制箱的维修保养前，必须先关闭电源并拔掉插头，并由专业人员进行操作。

## 1. 产品说明

### 1.1 产品规格

产品型号	全自动	工作电压	AC 220V ± 20% 50/60HZ
额定功率	550W	电机扭矩	≤ 3 N·M

### 1.2 接口插头说明

- ① 电机端口
- ② 电机编码器端口
- ③ 脚踏板端口
- ④ 机头灯组件端口
- ⑤ 电磁铁端口

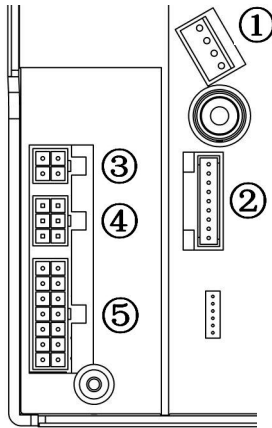

## 1.3 接口定义

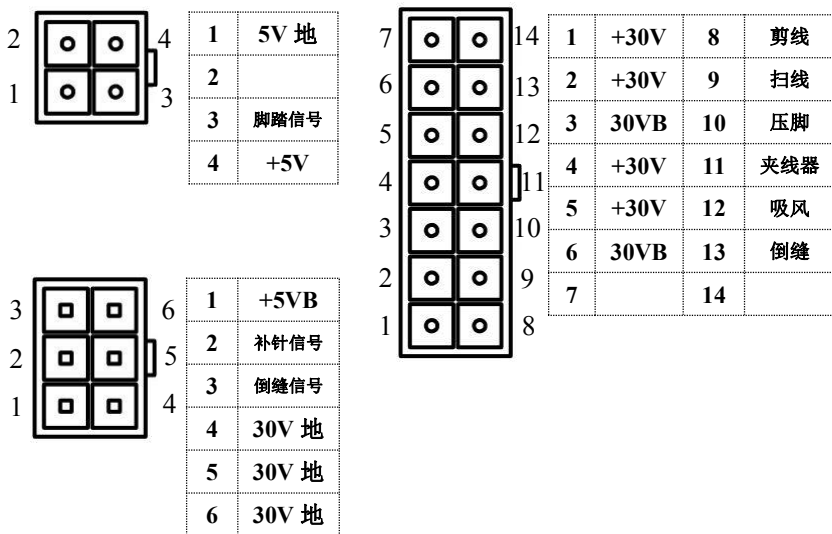

※ 请遵照接口定义及端子颜色相连接，如插不进去，请检查插座与针是否变形。

## 2. 操作面板使用说明

### 2.1 面板各按键功能说明

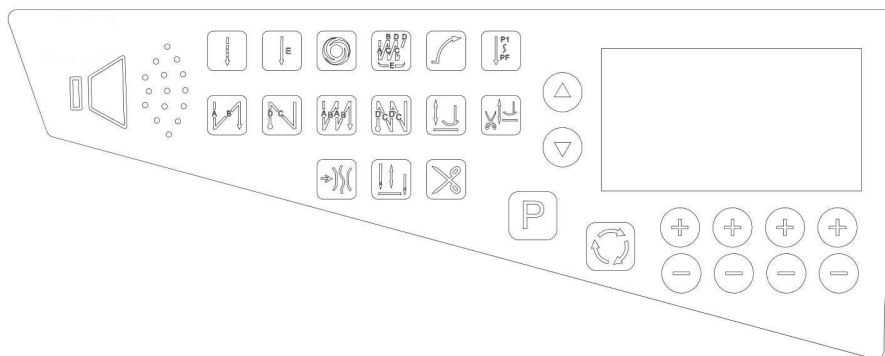





序号	图标	功能	按键功能描述
1		参数进入及返回键	按著此键两秒便可进入参数区。 参数区内此键可当参数递增键。
2		参数递增键	A, B, C, D 区的设定针数增加, 其设定值可选择从 0 到 F。(注) E, F, G, H 区的设定针数增加, 其设定值可选择从 0 到 99。 参数选择区内当参数递增键。 参数内容区内当设定数值递增键。 缝纫模式界面下速度加快捷键。
3		参数递减键	A, B, C, D 区的设定针数减少, 其设定值可选择从 0 到 F。(注) E, F, G, H 区的设定针数减少, 其设定值可选择从 0 到 99。 参数选择区内当参数递减键。 参数内容区内当设定数值递减键。 缝纫模式界面下速度减快捷键。
4		循环键	参数设定, 参数进入 在进入参数修改模式时, 作保存确认键。
5		触发自动 (AUTO)	1) . 在自由缝与连续缝的样式中: 按下此键蜂鸣器会声响, 但无功能 LED 亦不亮 2) . 在定针缝的样式能够按下此键: a. 当踏板一经往前踩下触发, 即自动执行 E, F 段或 G, H 段中选所设定的针数, 直到段内针数完成后始自动停止。 b. 再逐一触发踏板, 即自动执行下一段所设定的针数直到自动完成切线, 扫线动作为止。
6		自动剪线键	打开及关闭自动剪线功能。
7		自动抬压脚	打开及关闭自动抬压脚功能。
8		夹线键	打开及关闭自动夹线功能。

9		停针键	切换上下停针位。
10		慢速启动	电机启动时会先执行慢速启动的针数后继续正常车缝。
11		剪线后抬压脚键	打开及关闭剪线后抬压脚功能键。 液晶操控盒有显示时，切完线后压脚自动抬起。 液晶操控盒无显示时，切完线后压脚不动作。
12		自由缝键	自由缝模式
13		定针缝键	定针缝模式
14		前加固 1 次	执行前加固缝（A，B 段）1 次
15		后加固 1 次	执行后加固缝（C，D 段）1 次
16		前加固 2 次	执行前加固缝（A，B 段）2 次
17		后加固 2 次	执行后加固缝（C，D 段）2 次
18		多段定针缝	当使用 P1—PF 功能时，P1—P4 段的出厂设定针数为 15，如未用之段，其针数必须设为 0。
19		连续回缝	一旦踏板前踩下，就自动执行来回的连续回缝动作，来回次数由 E 段设定。 前踏之后即自动执行此功能到完成切线为止，中途是不会停止车缝，除非将踏板作往后踏解除动作。

**快捷语言切换：**按住 ，同时单击 P 键 ，会发出“滴”“滴滴”“滴滴滴”的声音，分别是不发声、中文语音、英文语音。

## 3. 系统参数设置

### 3.1 参数模式

1. 待机或剪线后，按  键 2 秒后进入用户参数设置；
2. 按   键选择参数；
3. 参数修改后需按  键保存修改后的参数。

参数号	中文名称	取值范围	默认值	参数说明
P01	最高转速	200~5000	3500	自由缝下最高转速
P02	加速度曲线	0~100	80	电机加速至最高速度的斜率
P03	停针位置	UP/DN	DN	中途停车车针位
P04	起始回缝速度	200~2800	1800	前加固的速度
P05	终止回缝速度	200~2800	1800	后加固的速度
P06	连续回缝速度	200~2800	1800	W 缝速度
P07	慢速起缝速度	200~2800	1800	慢速起缝速度
P08	慢起缝针数	1~99	2	慢起缝针数
P09	定针缝速度	200~5000	3000	自动定针缝速度
P10	自动回缝开关	ON/OFF	ON	定针缝，w 缝，定段缝结束时自动执行加固缝并剪线。
P11	保留			
P12	保留			
P13	低速区速度	200~800	200	脚踏轻微踩下的速度
P14	点动补针速度	200~800	300	点动补针的速度
P15	起始回缝补偿 1	0~359	195	前加固时倒缝电磁铁吸合时机
P16	起始回缝补偿 2	0~359	320	前加固时倒缝电磁铁释放时机
P17	终止回缝补偿 1	0~359	195	后加固时倒缝电磁铁吸合时机
P18	终止回缝补偿 2	0~359	320	后加固时倒缝电磁铁释放时机
P19	连续回缝补偿 1	0~359	195	W 缝模式下倒缝电磁铁吸合时机

P20	连续回缝补偿 2	0~359	320	W 缝模式下倒缝电磁铁释放时机
P21	自动触发开关	ON/OFF	ON	定段缝定针缝自动触发开关
P22	慢速起缝开关	ON/OFF	ON	慢速起缝开关
P23	自动抬压脚开关	ON/OFF	ON	自动抬压脚开关
P24	剪线后抬压脚开关	ON/OFF	ON	剪线后抬压脚开关
P25	电子夹线器开关	ON/OFF	ON	电子夹线器开关
P26	自动剪线开关	ON/OFF	ON	自动剪线开关
P27	中途抬压脚开关	ON/OFF	ON	中途抬压脚开关
P28	保留			
P29	保留			
P30	保留			
P31	保留			
P32	保留			
P33	补针方式	0/1/2	2	0: 半针 1: 一针 2: 连续
P34	当前脚踏电压值	0/1	0	0: 不显示 1 显示
P35	脚踏全后踏电压值	0~5000	300	全后踏剪线电压
P36	脚踏半后踏电压值	0~5000	550	半后踏抬压脚电压
P37	脚踏停针电压值	0~5000	1250	运转到停针的检测电压
P38	脚踏起转电压值	0~5000	1550	停止到运转的检测电压
P39	脚踏低速区电压值	0~5000	1800	低速运转最大电压
P40	脚踏最大电压值	0~5000	2700	脚踏调速区最大电压
P41	自动累积件数	0~9999	0	显示当前剪线次数
P42	主板版本号	只读	只读	主板版本号
P43	面板版本号	只读	只读	面板版本号
P44	反提针角度	0~320	0	剪线后反提针角度, 每 8 为一度
P45	保留			
P46	保留			
P47	保留			
P48	保留			

P49	保留			
P50	保留			
P51	历史错误记录	0~1	0	改成 1 保存可以参看历史错误记录
P52	密码	2018		改成 2018 进入高级参数
P53	保留			
P54	上停针自校准	0/1	0	上停针自校准
P55	下停针自校准	0/1	0	下停针自校准
P56	上停针位置	0~2880	2740	显示当前设置位置
P57	下停针位置	0~2880	1000	显示当前设置位置
P58	剪线进刀角度	0~359	18	剪线电磁铁吸合角度
P59	剪线加力角度	0~359	140	剪线时电机加力角度
P60	剪线退刀角度	0~359	190	剪线电磁铁释放角度
P61	剪线速度	150~500	300	剪线速度
P62	夹线器起始角度	0~359	100	电子夹线器吸合角度
P63	夹线器结束角度	0~359	330	电子夹线器释放角度
P64	夹线器全额输出	0~999	15	夹线全额输出时间
P65	夹线器吸合时间	0~999	3	夹线器吸合时间
P66	夹线器释放时间	0~99	2	夹线器释放时间
P67	抬压脚确认时间	0~999	200	踏板后踏时检测到抬压脚的确认时间
P68	压脚软着陆档位	0~999	90	压脚放下时电磁铁力度
P69	放压脚延迟时间	0~999	135	踏板前踩时，压脚放下经过延迟后再执行前踩动作
P70	后踏压脚保持时间	0~999	30	后踏压脚时，最大保持时间
P71	抬压脚全额时间	0~5000	1500	压脚电磁铁全额出力时间
P72	抬压脚吸合时间	0~999	15	压脚电磁铁吸合时间
P73	抬压脚释放时间	0~999	35	压脚电磁铁释放时间
P74	中途压脚保持时间	0~999	10	中途自动抬压脚最大保持时间
P75	保留			
P76	保留			



P77	保留			
P78	自动跑合开关	0/1	0	自动跑合开关
P79	跑合运转时间	0~999	20	跑合运转时间
P80	跑合停止时间	0~999	10	跑合停止时间
P81	倒缝全额时间	0~999	120	倒缝电磁铁全额出力时间
P82	倒缝吸合时间	0~999	2	倒缝电磁铁吸合时间
P83	倒缝释放时间	0~999	4	倒缝电磁铁释放时间
P84	最高速度锁定	200~5000	4000	用于限制 1 号参数
P85	剪线加力力度	0~100	60	剪线加力力度
P86	剪线后刹车力度	0~999	0	剪线后刹车力度
P87	剪线前刹车力度	0~999	20	剪线前刹车力度
P88	剪线后抬压脚延迟	0~999	0	剪线后抬压脚延迟
P89	保留			
P90	保留			
P91	保留			
P92	保留			
P93	位置控制参数 ks	0~40	26	位置控制时系数
P94	位置控制参数 ka	0~4028	4000	位置控制时系数
P95	位置控制参数 kb	0~4028	1000	位置控制时系数
P96	位置控制时间	0~999	150	位置控制时间
P97	安全开关检测	0/1	1	安全开关检测
P98	大电流检测	0~999	200	4s 持续大电流检测
P99	保留			
P100	保留			
P101	保留			
P102	保留			
P103	保留			
P104	保留			
P105	保留			

### 3.2 故障码





指示码	代码含义	解决方法
Err-o02	开机时脚踏未处于中立状态	1. 检查脚踏是否接触良好或者有无损坏
Err-o04	电机持续低速大电流输出（堵转）	1. 检查机械有无卡死现象 2. 检查电机线是否松动 3. 更换电机 4. 更换控制器并联系厂方
Err-o05	电机驱动电路过流报警	1. 检查机械是否过重或卡死 2. 关闭电源，再重新上电尝试修复 3. 更换控制器并联系厂方
Err-o06	上电找自校准失败	1. 检查电机线是否松动 2. 更换电机编码器
Err-o07	主板接受数据异常	1. 关闭电源，再重新上电尝试修复 2. 更换控制器
Err-o09	持续大电流工作	1. 关闭电源，再重新上电尝试修复 2. 更换控制器
Err-o11	面板上电读取 EEPROM 失败	1. 手动恢复出厂设置
Err-o12	保存 EEPROM 失败	1. 关闭电源，再重新上电
Err-o13	面板接收数据出错	1. 关闭电源，再重新上电
Err-o14	主板接收数据超时	1. 关闭电源，再重新上电

### 3.3 警示码

警示码	代码含义	说明
Attn-03	抬压脚超时	警示码不是故障代码，只是警示作用
Attn-08	安全开关倾倒	
Attn-10	母线电压偏低	

## 4. 快捷功能

#### 1. 修改上针位

按住  +  键，进入上针位修改界面， 键退出不保存， 键保存退出。

上针位修改之后会自动修改下针位，上至下针位需正转 140 度。

#### 2. 键 + 键修改语音音量。

#### 3. 长按 键查看缝纫件数，按 键清零件数。

# AUTOMatic Control box Operation Manual



## Safety Precautions:

- Before using this product, please read this Operation Manual and the sewing machine manual.
- Commissioning or operation must be performed by trained personnel.
- This product is only suitable for the sewing machine of the specified range. Do not use it for other purposes.
- Please keep away from high-frequency and high-radiation equipment as much as possible to avoid interference with the malfunction of this controller.
- When installing and maintaining the control box, turn off the power and unplug it.
- Make sure that the power and equipment are reliably grounded to prevent interference and leakage.
- All repair parts must be supplied or approved by the company before they can be used.
- Before performing maintenance on the control box, the power must be turned off and the plug removed and operated by a professional.

## 1. YyProduct Description

### 1.1 Product Specifications

Product number	AUTOMatic	Operating Voltage	AC 220V $\pm$ 20% 50/60HZ
rated power	550W	Motor torque	$\leq$ 3 N·M

### 1.2 Interface plug description

- ① Motor port
- ② Motor encoder port
- ③ Pedal port
- ④ Headlight assembly port
- ⑤ Electromagnet port

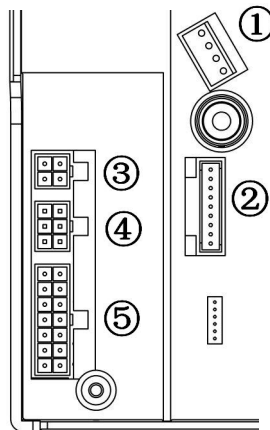

### 1.3 interface definition

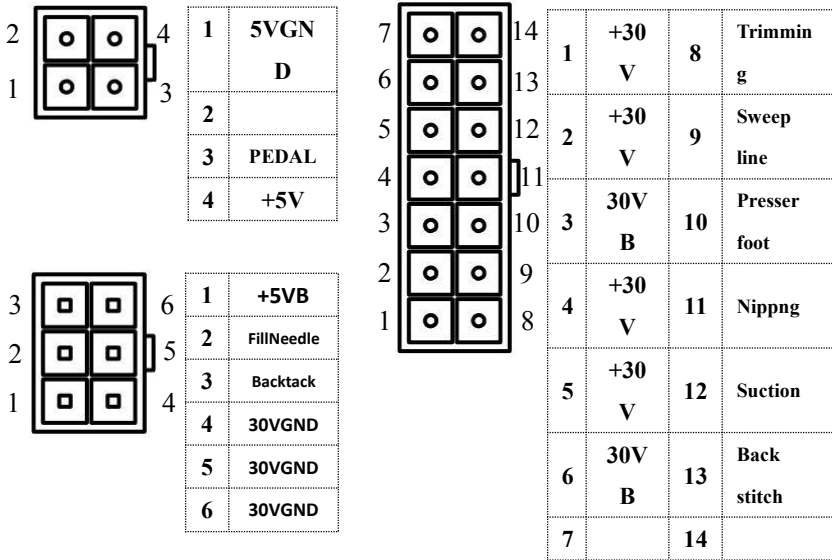







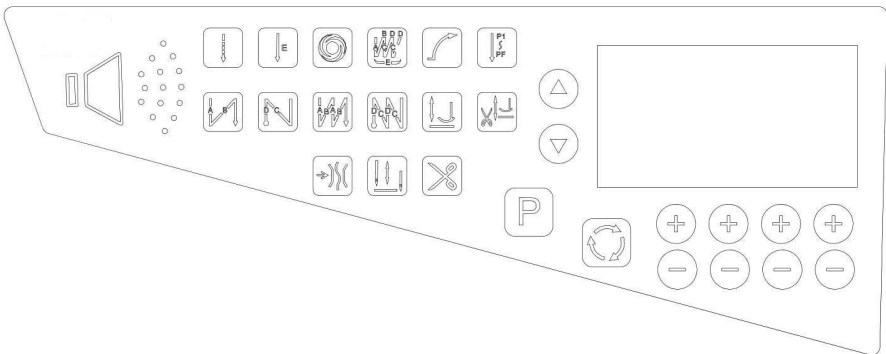





※ Please follow the interface definition and the color of the terminal. If it is not inserted, please check if the socket and the needle are deformed.







## 2. Operation Panel Instructions



### 2.1 PanelFunctionDescription



NO.	Icon	Features	Button Function Description
1		Parameter entry and return key	<p>Press this button for two seconds to enter the parameter area.</p> <p>This key in the parameter area can be used as a parameter increment key.</p>
2		Parameter increment key	<p>The number of stitches in the A, B, C, and D zones increases, and the set value can be selected from 0 to F. (Note)</p> <p>The number of stitches in the E, F, G, and H zones increases, and the set value can be selected from 0 to 99.</p> <p>The parameter increment key is used in the parameter selection area.</p> <p>When the parameter content area is set, the value increment key is set.</p> <p>Speed plus shortcut keys in the sewing mode interface.</p>
3		Parameter decrement key	<p>The number of stitches in the A, B, C, and D zones is reduced, and the set value can be selected from 0 to F. (Note)</p> <p>The number of stitches in the E, F, G, and H zones is reduced, and the set value can be selected from 0 to 99.</p> <p>The parameter decrement key is selected in the parameter selection area.</p> <p>When the parameter content area is set, the value decrement key is set.</p> <p>Speed reduction shortcut button in the sewing mode interface.</p>
4		Cycle key	<p>Parameter setting, parameter entry</p> <p>When entering the parameter modification mode, make a save confirmation key.</p>
5		Trigger auto (AUTO)	<p>1). In the style of free seam and continuous seam:</p> <p>When you press this button, the buzzer will sound, but the</p>

			<p>non-functional LED will not light.</p> <p>2). In the style of the fixed stitch, you can press this button:</p> <p>a. When the pedal is pressed forward, the E, F segment or G, and the segment number of the H segment are automatically selected, and the number of stitches is automatically selected until the number of stitches in the segment is completed.</p> <p>b. The pedals are triggered one by one, that is, the number of stitches set in the next segment is automatically executed until the tangent is automatically completed, and the thread is swiped.</p>
6		Automatic thread trimming button	Turn the automatic thread trimming function on and off.
7		Automatic lifting foot	Turns the automatic presser foot function on and off.
8		Clamp key	Turn the automatic threading function on and off.
9		Stop button	Switch the upper and lower needle stops.
10		Slow start	When the motor starts, the number of stitches of the slow start will be executed first and then the normal sewing will be continued.
11		Lift the presser button after trimming	<p>Turn the presser foot function key after turning the thread trimming on and off.</p> <p>When the LCD control box is displayed, the presser foot is automatically raised after the line is cut.</p> <p>When the LCD control box is not displayed, the presser foot does not move after the line is cut.</p>
12		Free sewing key	Free stitching mode

13		Fixed stitch key	Fixed stitch pattern
14		Reinforce 1 time before	Reinforcement joint (A, B) 1 time before execution
15		Reinforce 1 time	After the implementation of the reinforcement joint (C, D section) 1 time
16		2 times before reinforcement	Reinforcement joint (A, B) 2 times before execution
17		After reinforcement 2 times	After the implementation of the reinforcement joint (C, D section) 2 times
18		Multi-segment fixed stitch	When the P1-PF function is used, the number of pins set to the P1-P4 segment is 15, and the number of stitches must be set to 0.
19		Continuous back seam	Once the pedal is stepped on, the continuous back and forth motion is automatically performed, and the number of round trips is set by the E segment.  This function is automatically executed after the front step to complete the tangential line, and the sewing will not be stopped in the middle unless the pedal is stepped back.

**Fast language switching:** Press  and hold, while clicking the P button , it will emit the sound of “Drip” “Drip” “Drip”, which are no sound, Chinese voice, English voice.

### 3. System Parameter Setting

#### 3.1 Parameter mode

1. After standby or trimming, press the button  for 2 seconds to enter the user parameter setting;

2. Press the button   to select the parameter;

3. After the parameters are modified, you need to press the button  to save the modified parameters.

NO.	Chinese name	Ranges	Defaults	Parameter Description
P01	Maximum speed	200~500 0	3500	Free sewing speed
P02	Acceleration curve	0~100	80	The slope of the motor to the highest speed
P03	Needle stop position Needle stop position	UP/DN	DN	Midway parking needle position
P04	Starting back seam speed	200~280 0	1800	Front reinforcement speed
P05	End seam speed	200~280 0	1800	Speed of post-reinforcement
P06	Continuous sewing speed	200~280 0	1800	W seam speed
P07	Slow speed	200~280 0	1800	Slow speed Slow speed
P08	Slow stitching number	1~99	2	Slow stitching number
P09	Fixed stitch speed	200~500 0	3000	Automatic stitching speed
P10	Automatic back seam switch	ON/OFF	ON	Fixed stitching, w-sew, automatic



				stitching and thread trimming at the end of the fixed seam.
P11	Reserved			
P12	Reserved			
P13	Low speed zone speed	200~800	200	The speed at which the pedal is slightly depressed
P14	Jog fill speed	200~800	300	Jog fill speed
P15	Starting backlash compensation 1	0~359	195	Back-slot electromagnet suction timing during front reinforcement
P16	Starting backlash compensation 2	0~359	320	Reverse sewing electromagnet release timing during front reinforcement
P17	Terminate backlash compensation 1	0~359	195	Back-slit electromagnet suction timing
P18	Terminate backlash compensation 2	0~359	320	Back-slit electromagnet release timing after reinforcement
P19	Continuous backlash compensation 1	0~359	195	Back stitch electromagnet suction timing in W stitch mode
P20	Continuous backlash compensation 2	0~359	320	Reverse sewing electromagnet release timing in W stitch mode
P21	Automatic trigger switch	ON/OFF	ON	Fixed stitch sewing automatic trigger switch
P22	Slow starter switch	ON/OFF	ON	Slow starter switch
P23	Automatic presser foot switch	ON/OFF	ON	Automatic presser foot switch
P24	Post-cutting foot switch	ON/OFF	ON	Post-cutting foot switch
P25	Electronic wire clamp switch	ON/OFF	ON	Electronic wire clamp switch
P26	Automatic thread trimmer	ON/OFF	ON	Automatic thread trimmer
P27	Midway lift foot switch	ON/OFF	ON	Midway lift foot switch
P28	Reserved			
P29	Reserved			

P30	Reserved			
P31	Reserved			
P32	Reserved			
P33	Needle filling method	0/1/2	2	0: half stitch 1: one stitch 2: continuous
P34	Current pedal voltage value	0/1	0	0: Do not display 1 display
P35	Foot pedal full voltage value	0~5000	300	Full pedaling line voltage
P36	Foot pedal half step voltage value	0~5000	550	Half step back pressure foot voltage
P37	Foot stop voltage value	0~5000	1250	Detection voltage to run to stop needle
P38	Foot rotation voltage value	0~5000	1550	Stop detection voltage Stop detection voltage
P39	Foot low speed zone voltage value	0~5000	1800	Low speed running maximum voltage
P40	Foot pedal maximum voltage value	0~5000	2700	Foot speed zone maximum voltage
P41	Automatic accumulation	0~9999	0	Show current trimming times
P42	Motherboard version number	Read only	Read only	Motherboard version number
P43	Panel version number	Read only	Read only	Panel version number
P44	Reverse needle angle	0~320	0	Reverse the needle angle after trimming, every 8 degrees
P45	Reserved			
P46	Reserved			
P47	Reserved			
P48	Reserved			
P49	Reserved			
P50	Reserved			
P51	Historical error record	0-1	0	Change to 1 save can refer to historical error record
P52	password	2018		Changed to 2018 to enter advanced

				parameters
P53	Reserved			
P54	Upper needle self-calibration	0/1	0	Upper needle self-calibration
P55	Lower needle self-calibration	0/1	0	Lower needle self-calibration
P56	Upper needle position	0~2880	2740	Show current setting location
P57	Lower needle position	0~2880	1000	Show current setting location
P58	Trimming angle	0~359	18	Wire trimming electromagnet suction angle
P59	Trimming force angle	0~359	140	Motor force angle when trimming
P60	Cutting line retracting angle	0~359	190	Wire trimming electromagnet release angle
P61	Cutting speed	150~500	300	Cutting speed
P62	Wire gripper starting angle	0~359	100	Electronic wire gripper angle
P63	Wire gripper end angle	0~359	330	Electronic gripper release angle
P64	Wire clamp full output	0~999	15	Clip line full output time
P65	Wire gripper suction time	0~999	3	Wire gripper suction time
P66	Clamp release time	0~999	2	Clamp release time
P67	Lifting foot confirmation time	0~999	200	The confirmation time of the presser foot is detected when the pedal is stepped
P68	Presser foot soft landing gear	0~999	90	Electromagnet force when the presser foot is lowered
P69	Presser foot delay time	0~999	135	When the pedal is stepped on, the presser foot is lowered and then the front step is performed.
P70	Rear stepping foot hold time	0~999	30	Maximum hold time when stepping on the presser foot
P71	Lift the foot full time	0~5000	1500	Presser foot electromagnet full force output time

P72	Lifting foot suction time	0~999	15	Presser foot electromagnet pull-in time
P73	Lifting foot release time	0~999	35	Presser foot electromagnet release time
P74	Midway presser hold time	0~999	10	The maximum holding time of the automatic presser foot in the middle
P75	Reserved			
P76	Reserved			
P77	Reserved			
P78	Automatic running switch	0/1	0	Automatic running switch
P79	Running time	0~999	20	Running time
P80	Stop running time	0~999	10	Stop running time
P81	Backlash full time	0~999	120	Reverse stitching electromagnet full output time
P82	Reverse stitching time	0~999	2	Back-slit electromagnet pull-in time
P83	Backlash release time	0~999	4	Back-slit electromagnet release time
P84	Maximum speed lock	200~500 0	4000	Used to limit parameter number 1
P85	Trimming force	0~100	60	Trimming force
P86	Brake force after thread trimming	0~999	0	Brake force after thread trimming
P87	Front brake force	0~999	20	Front brake force
P88	Lifting foot delay after trimming	0~999	0	Lifting foot delay after trimming
P89	Reserved			
P90	Reserved			
P91	Reserved			
P92	Reserved			
P93	Position control parameter ks	0~40	26	Position control factor
P94	Position control parameter ka	0~4028	4000	Position control factor

P95	Position control parameter kb	0~4028	1000	Position control factor
P96	Position control time	0~999	150	Position control time
P97	Safety switch detection	0/1	1	Safety switch detection
P98	High current detection	0~999	200	4s continuous high current detection
P99	Reserved			
P100	Reserved			
P101	Reserved			
P102	Reserved			
P103	Reserved			
P104	Reserved			
P105	Reserved			

### 3.2 Error Code

Indicator code	Code meaning	Solution
<b>Err-o02</b>	The pedal is not in neutral when it is turned on	1. Check if the pedal is in good contact or damaged.
<b>Err-o04</b>	The motor continues to low speed and high current output (blocking)	1. Check if the machine is stuck or not. 2. Check if the motor line is loose. 3. Replace the motor 4. Replace the controller and contact the factory
<b>Err-o05</b>	Motor drive circuit overcurrent alarm	1. Check if the machine is too heavy or stuck. 2. Turn off the power and then power it on again. Try to repair. 3. Replace the controller and contact the factory.
<b>Err-o06</b>	Power-on to find self-calibration failed	1. Check if the motor wire is loose 2. Replace the motor encoder
<b>Err-o07</b>	The motherboard accepts data anomalies	1. Turn off the power, then power it on again and try to repair 2. Replace the controller
<b>Err-o09</b>	Continuous high current operation	1. Turn off the power, then power it on again and try to repair 2. Replace the controller
<b>Err-o11</b>	Failed to read EEPROM on panel	1. Manually restore factory settings



<b>Err-o12</b>	Saving EEPROM failed	1. Turn off the power and then turn it back on.
<b>Err-o13</b>	Panel receiving data error	1. Turn off the power and then turn it back on.
<b>Err-o14</b>	The motherboard receives data timeout	1. Turn off the power and then turn it back on.



### 3.3 Warning Code

Warning code	Code meaning
<b>Attn-03</b>	Lifting foot timeout
<b>Attn-08</b>	Safety switch dumping
<b>Attn-10</b>	Bus voltage is low

### 4. Quick Function

1. Modify the upper needle position

Press  and hold the + key  to enter the upper needle position modification

interface, the key  exits without saving, and the key  saves and exits.

After the upper needle position is modified, the lower needle position will be automatically modified, and the upper to lower needle position needs to be rotated forward by 140 degrees.

2. Key  + key   to modify the voice volume.

3. Press the long button  to view the number of sewing pieces, and press the

button  to clear the number of parts.